



DURANTE

ALIVAR

ITALIAN DESIGN CULTURE



DURANTE

amore per unicità,
qualità e sobrietà.
Il focus è sul comfort,
sui dettagli e sulla
qualità dei materiali.

LOVE FOR UNIQUENESS, QUALITY AND SOBRIETY.
THE FOCUS IS ON COMFORT,
DETAILS AND QUALITY OF MATERIALS.



DURANTE_
SISTEMA COMPONIBILE
DI DIVANI CHE INTERPRETA UN
LUSSO CONTEMPORANEO
DALL' APPEAL MORBIDO E
INFORMALE,
CON LA FUNZIONALITÀ
UNICA DEL TERMINALE
GIREVOLE.

DURANTE_
MODULAR SYSTEM
OF SOFAS THAT INTERPRETS CONTEMPORARY LUXURY
WITH A SOFT AND INFORMAL APPEAL,
WITH UNIQUE FUNCTIONALITY
OF THE SWIVEL ENDING ELEMENT.



DURANTE_ SI MUOVE SUL FILO
DELL' EQUILIBRIO TRA SEMPLICITÀ
E MORBIDA OPULENZA.

DURANTE_ MOVES ON THE THREAD
OF BALANCE BETWEEN SIMPLICITY
AND SOFT OPULENCE.





UN LUSSO RILASSATO
ED ELEGANTE,
TRANQUILLO E NON GRIDATO,
VERSATILE E DUREVOLE.

A RELAXED
AND ELEGANT LUXURY,
QUIET AND NOT SHOUTY,
VERSATILE AND DURABLE.





LA FLESSIBILITÀ È UN'IMPORTANTE PECULIARITÀ DELLA COLLEZIONE DURANTE CHE PUÒ ADATTARSI A DIVERSI CONTESTI E CREARE NUOVI SCENARI DOMESTICI. GLI ELEMENTI DELLE SEDUTE MODULARI POSSONO FORMARE VARIE COMPOSIZIONI E SONO PERFETTI PER SPAZI DI TUTTE LE MISURE, PER OFFRIRE MASSIMA LIBERTÀ ESPRESSIVA. AL CENTRO C'È L'IDEA DI CREARE SPAZI CHE ESPRIMONO IL COMFORT, MA PUNTANO ANCHE SULLA FUNZIONALITÀ.

FLEXIBILITY IS AN IMPORTANT PECULIARITY OF THE DURANTE COLLECTION WHICH CAN ADAPT TO DIFFERENT CONTEXTS AND CREATE NEW DOMESTIC SCENARIOS. THE ELEMENTS OF THE MODULAR SEATS CAN FORM DIFFERENT COMBINATIONS AND ARE PERFECT FOR SPACES OF ALL SIZES, TO OFFER MAXIMUM EXPRESSIVE FREEDOM. AT THE CENTER IS THE IDEA OF CREATING SPACES THAT EXPRESS COMFORT, BUT ALSO FOCUS ON FUNCTIONALITY.



DURANTE_ modello brevettato, patented model angelettiruzza design

Divano / poltrona. Base in legno ricoperta in poliuretano indeformabile e fodera in fibra di poliestere. Spalliere e braccioli in acciaio ricoperti in poliuretano. Cuscini seduta in poliuretano a densità differenziata e trapunta in piuma sterilizzata. Cuscini spalliera in piuma sterilizzata con inserto in gomma poliuretanicca. Rivestimento in pelle o tessuto. Appoggio a terra con piedini antiscivolo.

Sofa / armchair. Wooden base upholstered with non-deformable polyurethane foam and polyester fiber lining. Backs and armrests in steel upholstered with polyurethane foam. Seat cushions in polyurethane foam of different densities and quilt in sterilized feathers. Back cushions in polyurethane foam covered with a lining filled with sterilized feathers. Fabric or leather cover. Non-slip feet.

Divani / Sofas

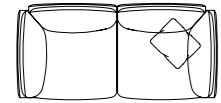
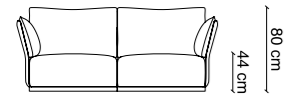

ART. DUR 227
L/W 227 H 96 P/D 108
W 89,4" H 37,8" D 42,5"

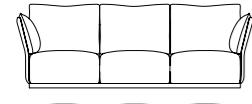

ART. DUR 267
L/W 267 H 96 P/D 108
W 105,1" H 37,8" D 42,5"

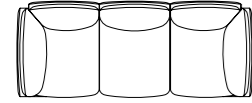

ART. DUR 307
L/W 307 H 96 P/D 108
W 120,9" H 37,8" D 42,5"

ART. DUR 327
L/W 327 H 96 P/D 108
W 128,7" H 37,8" D 42,5"

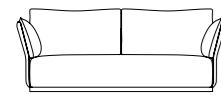

ART. DUR 226 DX/SX
L/W 226 H 96 P/D 167
W 89" H 37,8" D 65,7"

DX/RIGHT

Poltrona e pouf / Armchair and ottoman



ART. PUR100
Ø 100 H 96
Ø 39,4" H 37,8"

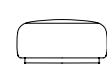

ART. PPUR90
Ø 90 H 44
Ø 35,4" H 17,3"

Elementi centrali / Central elements



ART. DURC 80
L/W 80 H 96 P/D 108
W 31,5" H 37,8" D 42,5"

ART. DURC 100
L/W 100 H 96 P/D 108
W 39,4" H 37,8" D 42,5"



ART. DURC 160
L/W 160 H 96 P/D 108
W 63" H 37,8" D 42,5"

ART. DURC 180
L/W 180 H 96 P/D 108
W 70,9" H 37,8" D 42,5"

ART. DURC 200
L/W 200 H 96 P/D 108
W 78,7" H 37,8" D 42,5"

Elementi angolari / Corner elements



DX/RIGHT

ART. DURA 157 DX/SX
L/W 157 H 96 P/D 120
W 61,8" H 37,8" D 47,2"

ART. DURA 194 DX/SX
L/W 194 H 96 P/D 130
W 76,4" H 37,8" D 51,2"

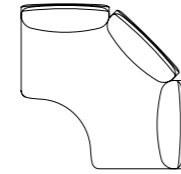

ART. DURA 187
L/W 187 H 96 P/D 187
W 73,6" H 37,8" D 73,6"

Elementi terminali / Ending elements



SX/LEFT

ART. DURT 195 DX/SX
L/W 195 H 96 P/D 118
W 76,8" H 37,8" D 46,5"

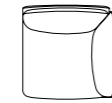

DX/RIGHT

ART. DURT 93 DX/SX
L/W 93 H 96 P/D 108
W 36,6" H 37,8" D 42,5"

ART. DURT 113 DX/SX
L/W 113 H 96 P/D 108
W 44,5" H 37,8" D 42,5"



DX/RIGHT

ART. DURT 174 DX/SX
L/W 174 H 96 P/D 108
W 68,5" H 37,8" D 42,5"

ART. DURT 194 DX/SX
L/W 194 H 96 P/D 108
W 76,4" H 37,8" D 42,5"



DX/RIGHT

ART. DURT 214 DX/SX
L/W 214 H 96 P/D 108
W 84,3" H 37,8" D 42,5"

Elementi terminali a penisola / Peninsula ending elements



DX/RIGHT

ART. DURT 190 DX/SX
L/W 190 H 96 P/D 147
W 74,8" H 37,8" D 57,9"



DX/RIGHT

ART. DURP 174 DX/SX
L/W 174 H 96 P/D 167
W 68,5" H 37,8" D 65,7"

ART. DURP 214 DX/SX
L/W 214 H 96 P/D 167
W 84,3" H 37,8" D 65,7"



DX/RIGHT

ART. DURP187 DX/SX
L/W 187 H 96 P/D 200
W 76,3" H 37,8" D 78,7"



DX/RIGHT

ART. DURP156 DX/SX
L/W 156 H 96 P/D 134
W 61,4" H 37,8" D 52,8"

ART. DURP190 DX/SX
L/W 190 H 96 P/D 144
W 74,8" H 37,8" D 56,7"



DX/RIGHT

ART. DURP160 DX/SX
L/W 160 H 96 P/D 167
W 63" H 37,8" D 65,7"

ART. DURP200 DX/SX
L/W 200 H 96 P/D 167
W 78,7" H 37,8" D 65,7"

Possibili composizioni / Possible combinations

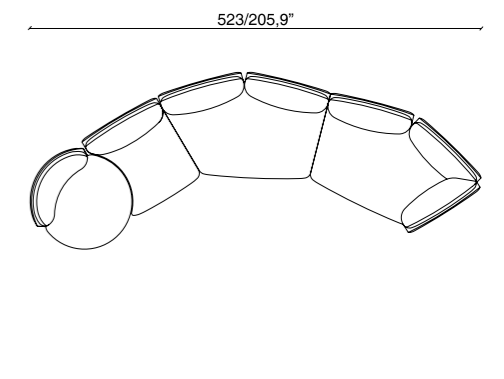
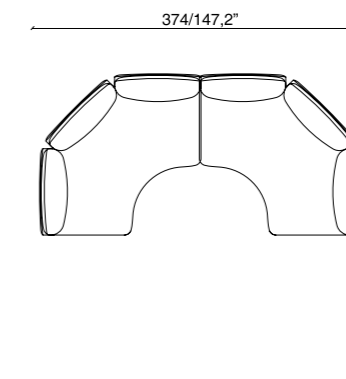
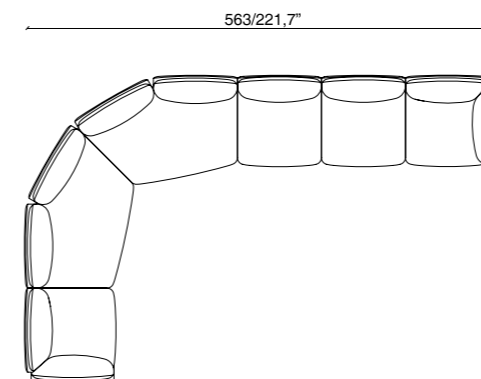
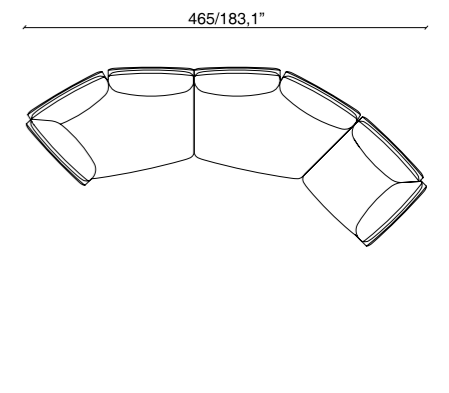
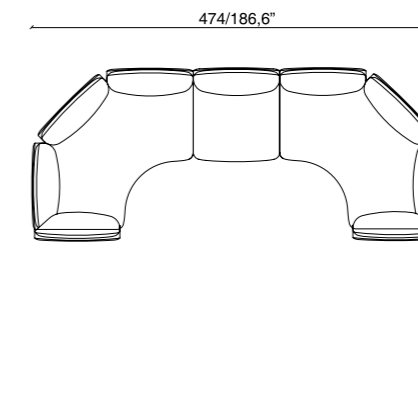
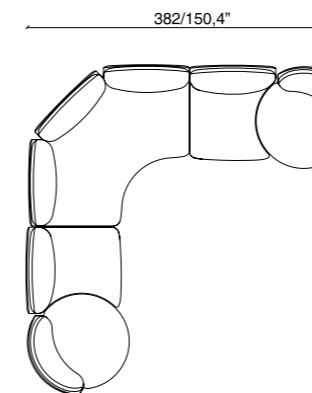
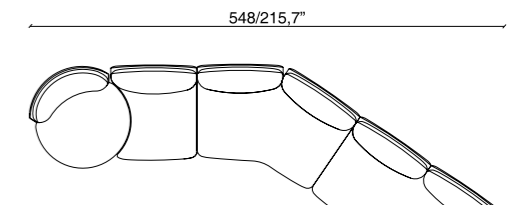
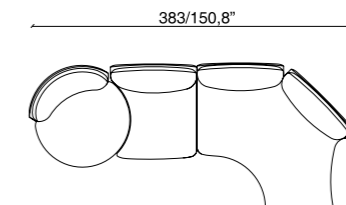
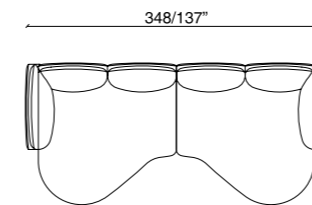
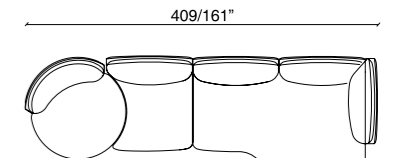
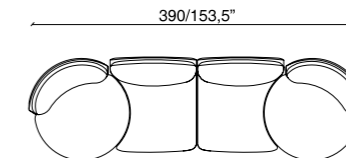
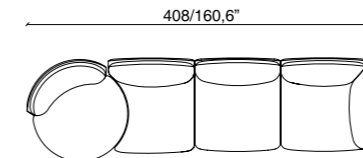



OLMO_
MAESTOSO EQUILIBRIO:
IL TAVOLO DAL CARISMA
IMPAREGGIABILE
CHE INFONDE
ARMONIA.

OLMO_
MAJESTIC BALANCE:
THE TABLE WITH UNRIVALED CHARISMA
THAT INFUSES
HARMONY.





OLMO
angelettiruzza design

Tavolo. Base d'appoggio in metallo laccato formata da tubi Ø 70 mm uniti tra loro. La base poggia a terra con scivolanti protettivi in PVC. Piano in frassino verniciato a poro aperto spessore 19 mm, noce spessore 19 mm, MDF laccato opaco 19 mm, marmo spessore 19 mm o ceramica spessore 5 mm, accoppiata con vetro trasparente extra chiaro spessore 10 mm

Table. Base in lacquered steel made of tubes Ø 70 mm joined together. Protective PVC glides. Top in open pore painted ash 19 mm, thick, walnut 19 mm, thick, matt lacquered MDF 19 mm, thick, marble 19 mm thick or ceramic 5 mm, thick coupled with extra clear transparent glass 10 mm, thick.

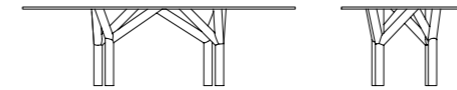
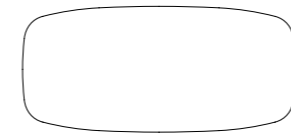

ART. TMO260
L/W 260 H 75 P/D 120
W 102,4" H 29,5" D 47,2"

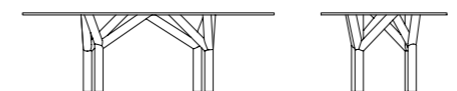

ART. TMO240
L/W 240 H 75 P/D 110
W 94,5" H 29,5" D 43,3"

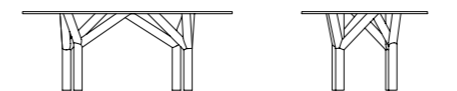
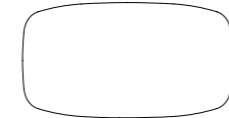

ART. TMO200
L/W 200 H 75 P/D 110
W 78,7" H 29,5" D 43,3"

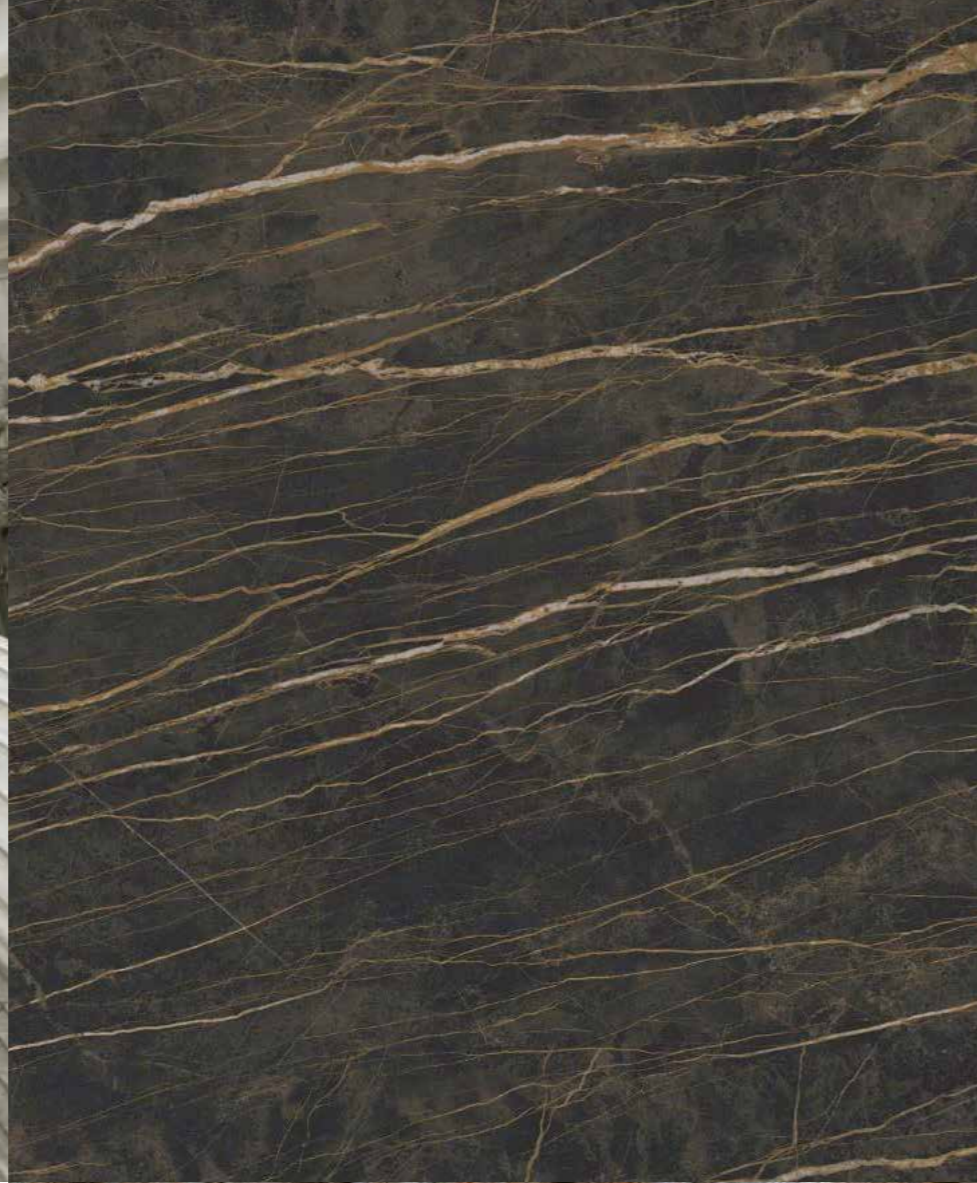

TERRAFERMA_
ELEGANZA IN ASCESA:
IL TAVOLO CON GAMBA CENTRALE
DALL'INCONFONDIBILE
PRESENZA
MATERICA.

TERRAFERMA_
ELEGANCE ON THE RISE:
THE TABLE WITH A CENTRAL LEG WITH AN
UNMISTAKABLE MATERIAL
PRESENCE .







TERRAFERMA
angelettiruzza design

Tavolo allungabile. Basamento centrale a cono; parte superiore in acciaio verniciato, parte inferiore in MDF laccato opaco o impiallacciato in frassino o noce. Piano con un meccanismo di allunga manuale a scomparsa. Le 2 allunghe laterali sono estraibili singolarmente, basta tirarle verso di sé per farle scorrere da sotto il piano ed allinearle con un semplice movimento, permettendo di raggiungere i 280 cm di lunghezza. Il piano è disponibile in ceramica spessore 12 mm, o in cristallo fumé temperato spessore 12 mm.

Extendable table. Central cone-shaped base; upper part in painted steel, lower part in matt lacquered MDF or veneered in ash or walnut. Top with a retractable manual extension mechanism. The 2 side extensions can be removed individually, just pull them towards you to slide them from under the top and align them with a simple movement, allowing you to reach 280 cm in length. The top is available in ceramic 12 mm. thick or in smoke-grey tempered glass 12 mm. thick.

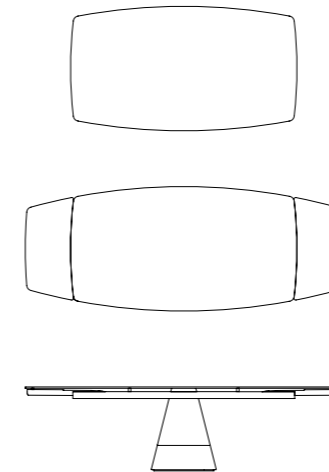

ART. TFR200A
L/W 200/240/280 H 74 P/D 110
W 78,7"/94,5"/110,2" H 29,1" D 43,3"

Tavolo. Basamento centrale a cono; parte superiore in acciaio verniciato, parte inferiore in MDF laccato opaco o impiallacciato in frassino o noce. Sottopiano in metallo laccato. Il piano è disponibile in marmo, frassino verniciato a poro aperto, noce, MDF laccato opaco o ceramica spessore 5 mm, accoppiata con vetro trasparente extra chiaro spessore 10 mm.

Table. Central cone-shaped base; upper part in painted steel, lower part in matt lacquered MDF or veneered in ash or walnut. Lacquered metal support. The top is available in marble 19 mm. thick, open pore painted ash 19 mm. thick, walnut 19 mm. thick, matt lacquered MDF 19 mm. thick or ceramic 5 mm. thick coupled with extra clear transparent glass 10 mm. thick.

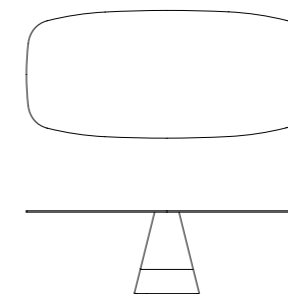

ART. TFRT210
L/W 210 H 74 P/D 110
W 82,7" H 29,1" D 43,3"

ART. TFRT240
L/W 240 H 74 P/D 110
W 94,5" H 29,1" D 43,3"

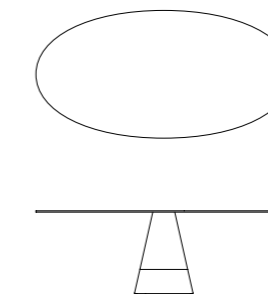

ART. TFRO180
L/W 180 H 74 P/D 110
W 70,9" H 29,1" D 43,3"

ART. TFRO220
L/W 220 H 74 P/D 110
W 86,6" H 29,1" D 43,3"

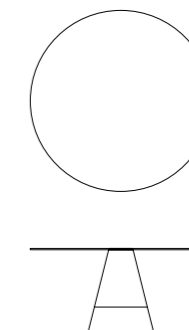

ART. TFR120
Ø 120 H 74
Ø 47,2" H 29,1"

ART. TFR140
Ø 140 H 74
Ø 55,1" H 29,1"

ART. TFR160
Ø 160 H 74
Ø 63" H 29,1"



TIMEO ROUND_
UN NIDO ACCOGLIENTE
CON CUSCINI
IN PIUMA AVVOLGENTI.
IN PIUMA AVVOLGENTI.

TIMEO ROUND_
A WELCOMING NEST WITH
ENVELOPING
DOWN PILLOWS.





PUREZZA IN ARMONIA:
IL FASCINO ESSENZIALE DI UN GRANDE LETTO ROTONDO CHE DOMINA LA SCENA E ARREDA IL
CUORE DELLA STANZA CON STILE INCONFONDIBILE.

PURITY IN HARMONY:
THE ESSENTIAL CHARM OF A LARGE ROUND BED THAT DOMINATES THE SCENE AND FURNISHES THE
HEART OF THE ROOM WITH UNMISTAKABLE STYLE.





TIMEO_
NELLA VERSIONE
SQUARE È UNA PRESENZA
EQUILIBRATA E DISTINTA,
UN' OASI DI TRANQUILLITÀ
CHE TRASMETTE
CALMA,
ACCOGLIENZA E RELAX.

TIMEO_
IN THE SQUARE VERSION
IS A BALANCED AND DISTINCT PRESENCE,
AN OASIS OF TRANQUILLITY THAT
TRANSMITS CALM, WELCOME
AND RELAXATION.





TIMEO ROUND
angelettirizza design

Letto rotondo. Struttura in acciaio verniciato rivestito in gomma poliuretanicca e fodera in fibra di poliestere. Cuscini testata in piuma sterilizzata. Appoggio per materasso su piani in legno forati per una corretta areazione. Rivestimento in tessuto o pelle. Appoggio a terra con piedini antiscivolo.

Round bed. Painted steel frame upholstered with polyurethane foam and polyester fiber lining. Headboard cushions in sterilized feathers. Mattress support on perforated wooden platforms for correct ventilation. Fabric or leather cover. Non-slip feet.

ART. LTM240
L/W 257 H 92 P/D 272
W 101,2" H 36,2" D 107,1"
materasso Ø 240
mattress Ø 94,5"

materasso / mattress
ART. MTM240
Ø 240 H 21
Ø 94,5" H 8,3"

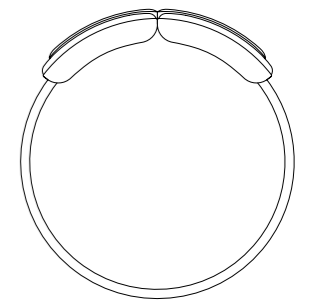
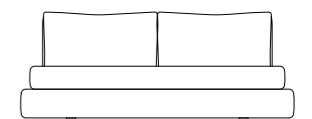
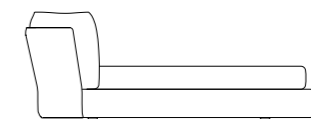

TIMEO
angelettirizza design

Letto. Testata in metallo rivestita in poliuretano. Cuscini testata in piuma sterilizzata con fodera 100% cotone e inserto di poliuretano espanso. Giroletto in multistrato di abete rivestito in poliuretano espanso e vellutino accoppiato. Appoggio a terra con piedini antiscivolo. Rivestimento in pelle o tessuto. Giroletto e cuscini testata sioderabili. Rete in multistrato di betulla con doghe curve da 25 mm con regolatori di rigidità nella zona lombare. Disponibile anche con il contenitore alzabile.

Bed. Headboard in steel padded with polyurethane foam. Headboard cushions in sterilized feather with 100% cotton lining and polyurethane foam insert. Bed edge frame in fir multilayer covered with polyurethane foam and fiber wadding. Non-slip feet. Leather or fabric cover. Removable bed edge and headboard cushions cover. Slatted base in birch multilayer with mm. 25 bent slats with hardness adjuster for the lumbar area. Also available with storage base and lift-up slatted bed frame.

ART. LTM1S - Standard
L/W 230 H 94 P/D 231
W 90,6" H 37" D 90,9"
materasso L/W 170 P/D 200
mattress W 66,9" D 78,7"

ART. LTM1Q - Queen
L/W 212 H 94 P/D 234
W 83,5" H 37" D 92,1"
materasso L/W 153 P/D 203
mattress W 60,2" D 79,9"

ART. LTM1K - King 2X2
L/W 259 H 94 P/D 231
W 102" H 37" D 90,9"
materasso L/W 200 P/D 200
mattress W 78,7" D 78,7"

ART. LTM1E - Europe
L/W 239 H 94 P/D 231
W 94,1" H 37" D 90,9"
materasso L/W 180 P/D 200
mattress W 70,9" D 78,7"

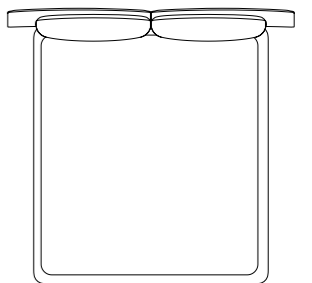
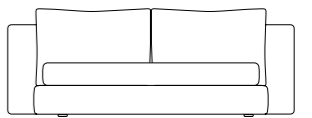
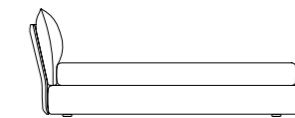

ARBORÈ_
MATERIALI PREGIATI,
FORME LINEARI:
ESSENZA CHE DIVENTA
ECCELLENZA PER UN LETTO
CHE UNISCE SEMPLICITÀ
E QUALITÀ
SUPERLATIVA.

ARBORÈ_
PRECIOUS MATERIALS, LINEAR SHAPES:
AN ESSENCE THAT BECOMES EXCELLENCE
FOR A BED WHICH COMBINES SIMPLICITY
AND SUPERLATIVE QUALITY.







ARBORÈ

design: Alessandro Corina

Letto a baldacchino. Struttura in massello di frassino naturale o verniciato. Giunti in metallo verniciato. Testata in MDF rivestito in gomma poliuretanic e fodera in fibra di poliestere. Rivestimento testata in pelle o tessuto. Appoggio per materasso su pianali in legno forato per una corretta areazione. Piedini in metallo.

Canopy bed. Frame in natural or painted solid ash. Painted metal joints. Headboard in MDF upholstered with polyurethane foam and polyester fiber lining. Headboard cover in leather or fabric. Mattress support on perforated wooden platforms for correct ventilation. Metal feet.

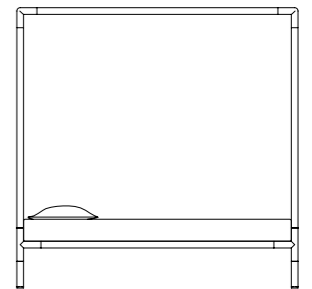
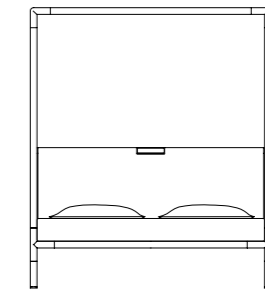

ART. LRB1S Standard
L/W 180 H 210 P/D 210
W 70,9" H 82,7" D 82,7"
materasso L/W 170 P/D 200
mattress W 66,9" D 78,7"

ART. LRB1Q - Queen
L/W 163 H 210 P/D 213
W 64,2" H 82,7" D 83,9"
materasso L/W 153 P/D 203
mattress W 60,2" D 79,9"

ART. LRB1K - King2X2
L/W 210 H 210 P/D 210
W 82,7" H 82,7" D 82,7"
materasso L/W 200 P/D 200
mattress W 78,7" D 78,7"

ART. LRB1E - Europe
L/W 190 H 210 P/D 210
W 74,8" H 82,7" D 82,7"
materasso L/W 180 P/D 200
mattress W 70,9" D 78,7"

COLOURS AND FINISHES

La qualità certificata del Made in Italy Alivar, fatta di lavorazioni tradizionali e di materiali prestigiosi, diventa il valore di un arredo dove lo stile è un'esperienza concreta, una collezione nata dalla creatività formale e dalla sensibilità per la materia, un viaggio nella bellezza dello spazio contemporaneo.

Alivar anticipa e interpreta l'abitare contemporaneo e crea uno stile sempre attuale, che va oltre le tendenze.

The certified quality of Alivar's Made in Italy all traditionally-made using top-quality materials, becomes the focal point of furnishings where style is an experience to be explored.

A collection born from formal creativity and sensibility for materials and a journey into the beauty of contemporary spaces.

Alivar anticipates and interprets modern living and create a contemporary style which is timeless.

ESSENZE / WOOD



Frassino tinto "Rovere"
"Oak"-stained ash



Frassino tinto grigio
Grey-stained ash



Frassino tinto wengé
Wengé-stained ash

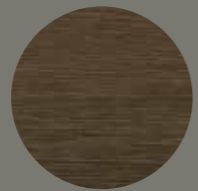

Frassino tinto termotrattato
Heat-treated stained ash



Frassino nero
Black ash



Rovere termotrattato
Heat-treated oak



Rovere nero
Black oak



Noce "Nazionale"
"Italian" walnut



Ebano
Ebony



Palissandro
Rosewood



Palissandro decorato
Decorated Rosewood

LACCATURE PER LEGNO / WOODEN LACQUERS

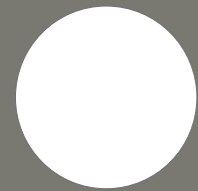

RAL 9016
Bianco lucido - opaco
Glossy - matt white



0181
Crema lucido - opaco
Glossy - matt cream



D 050.70.10
Cipria lucido - opaco
Glossy - matt powder



15.65
Sabbia lucido - opaco
Glossy - matt sand



D 080.60.30
Scnape lucido - opaco
Glossy - matt mustard



05.70
Tortora lucido - opaco
Glossy - matt dove brown



10.60
Corda lucido - opaco
Glossy - matt rope



05.60
Grigio lucido - opaco
Glossy - matt grey



RAL 7006
Castoro lucido - opaco
Glossy - matt beaver



D 060.10.05
Fango lucido - opaco
Glossy - matt mud



D 220.60.10
Winter blue lucido - opaco
Glossy - matt winter blue



D 260.10.10
Lavanda lucido - opaco
Glossy - matt lavender



RAL 6033
Menta lucido - opaco
Glossy - matt mint



D 200.10.10
Azavola lucido - opaco
Glossy - matt teal



D 110.10.05
Verde salvia lucido - opaco
Glossy - matt sage green

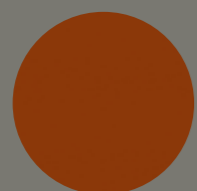

RAL 8004
Ruggine lucido - opaco
Glossy - matt rust

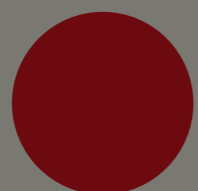

10.20
Rosso scuro lucido - opaco
Glossy - matt dark red



RAL 3007
Amaranto lucido - opaco
Glossy - matt amaranth



D 100.60.05
Grigio lucido - opaco
Glossy - matt grey



RAL 9005
Nero lucido - opaco
Glossy - matt black

LACCATURE & FINITURE PER METALLO / STEEL LACQUERS & FINISHES

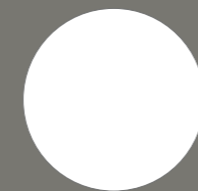

RAL 9016
Bianco opaco
Matt white



RAL 1013
Crema
Cream



RAL 7006
Castoro
Beaver

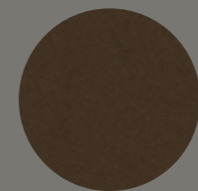

1820
Ruggine perlato
Rusty pearl

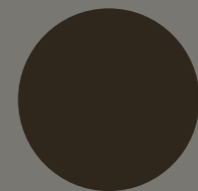

RAL 8019
Testa di moro opaco
Matt dark brown

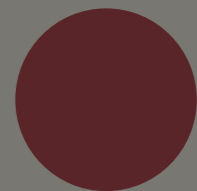

RAL 3007
Amaranto
Amaranth



Alluminio cromo
Alu chrome

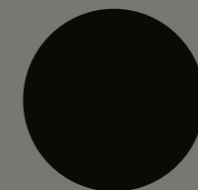

RAL 9005
Nero opaco
Matt black

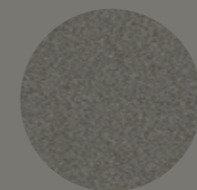

Alluminio gofrato
Embossed aluminium

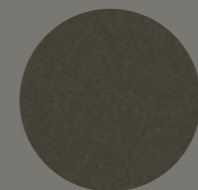

320
Nero perlato
Black pearl



Bronzo graffiato a
mano Hand- scratched
bronze



Titanio
Titanium



Champagne

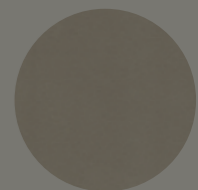

Laccatura Peltrox
Peltrox lacquer

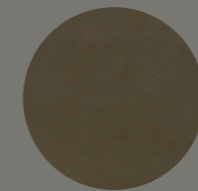

Bronzo
Bronze

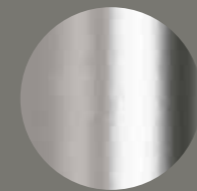

Cromo
Chrome

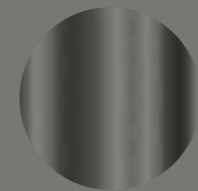

Nickel nero
Black nickel

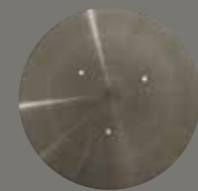

art. T Gong
Finitura Peltrox
Peltrox finish

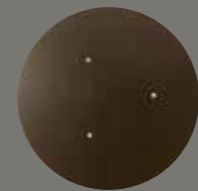

art. T Gong
Finitura Bronzo
Bronze finish

MARMI & PIETRE / MARBLES & STONES



Marmo "Marquiniá"
nero
Black "Marquiniá"
marble

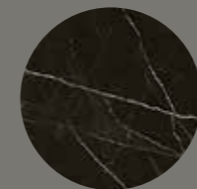

Marmo "Calacatta"
Black "Black Calacatta"
marble



Marmo "Noir Saint
Laurent" nero
Black "Noir Saint
Laurent" marble



Marmo "Michelangelo"
bianco
White "Michelangelo"
marble



Marmo "Calacatta"
bianco
White "Calacatta" marble

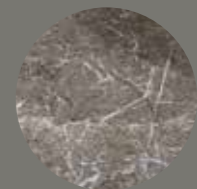

Marmo "Oriente" grigio
Grey "Oriente" marble

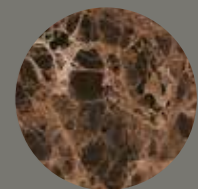

Marmo "Emperador"
marrone
Brown "Emperador"
marble

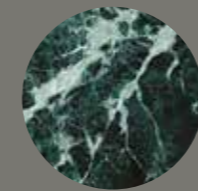

Marmo "Alpi" verde
Green "Alpi" marble

CERAMICA / CERAMIC



Bianco "White
CeramiKa "Gold"



Bianco "White
CeramiKa "Statuario"



Nero "Black CeramiKa
"Noir"

DURANTE

ALIVAR
ITALIAN DESIGN CULTURE

ALIVAR srl
Via Leonardo Da Vinci, 118/14
50028 Barberino Tavarnelle, Firenze - Italy
t. + 39 055 80 70115 - f. + 39 055 80 70127
alivar@alivar.com

↳ 100% Made in Italy
certificate N° IT01.IT_456.110.M
National register of Italian
manufacturers



